

Specifications:

Sound level Category	Medium Sound Level
Mode of Operation	Continuous tone
Mounting	Panel (see note B)
Voltage Rating	30 to 120 Vac/dc
Frequency	4500 Hz ±500 Hz
Loudness (Min. Voltage)	68 dB(A) min. @ 2 FT and 30 Vac/dc
Loudness (Max Voltage)	80 dB(A) min. @ 2 FT and 120 Vac/dc
Current Draw	6 mA Max @ 30 Vac/dc
Current Draw	20 mA Max @ 120 Vac/dc
Storage Temperature	-40°C to +85°C
Operating Temperature	-30°C to +65°C
Weight (Typical)	2.1 oz (59 g)
Housing	6/6 Nylon, Color Black
Options	For other options contact factory

Dimensions: Inches (mm)



PART DIMENSIONS BEFORE CODE DATE 0824 5

PART DIMENSIONS AFTER CODE DATE 0825 1

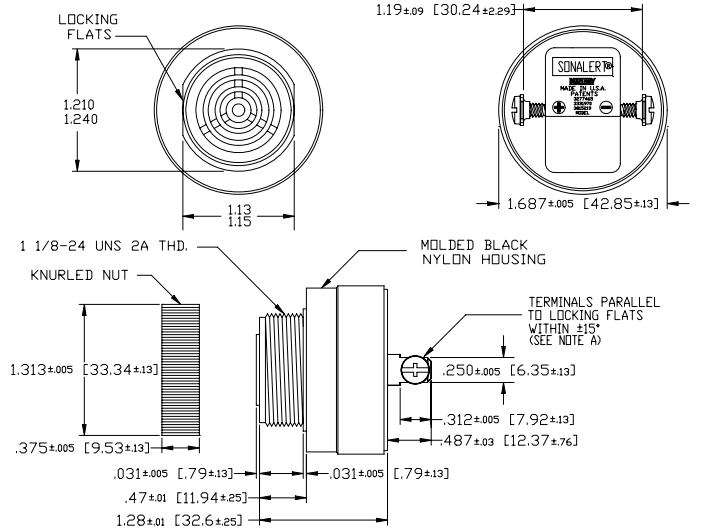
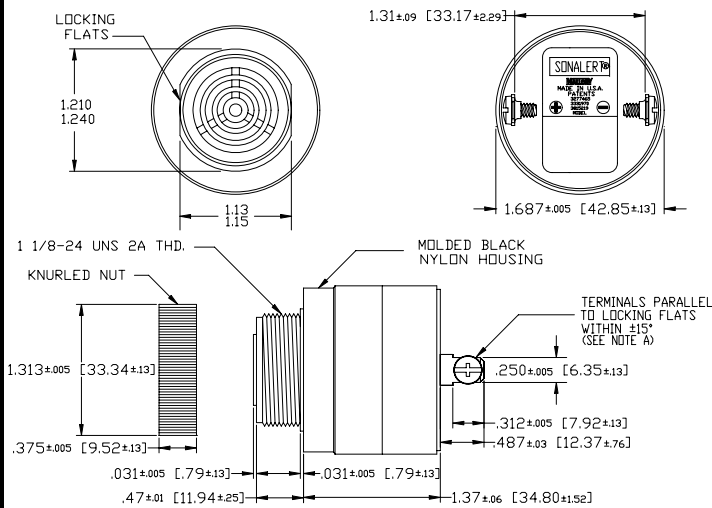

NOTE A: TERMINALS-.032 BRASS TIN PLATED, TAPPED FOR #6-32 SCREW. TWO #6-32 NICKEL PLATED BRASS SCREWS INCLUDED. WILL ACCEPT 1/4" QUICK CONNECT.

NOTE B: MOUNTING- REMOVE BLACK PLASTIC NUT AND INSERT THREADED FRONT THROUGH 1.25" HOLE PUNCHED IN PANEL, IF ORIENTATION IS NEEDED, NOTE LOCKING FLATS ON DRAWING. SCREW NUT BACK ON. DO NOT OVERTIGHTEN.

NOTE A: TERMINALS-.032 BRASS TIN PLATED, TAPPED FOR #6-32 SCREW. TWO #6-32 NICKEL PLATED BRASS SCREWS INCLUDED. WILL ACCEPT 1/4" QUICK CONNECT.

NOTE B: MOUNTING- REMOVE BLACK PLASTIC NUT AND INSERT THREADED FRONT THROUGH 1.25" HOLE PUNCHED IN PANEL, IF ORIENTATION IS NEEDED, NOTE LOCKING FLATS ON DRAWING. SCREW NUT BACK ON. DO NOT OVERTIGHTEN.